

Arch. Bonnard Woffray

# CS 86-HI

Highly energy efficient

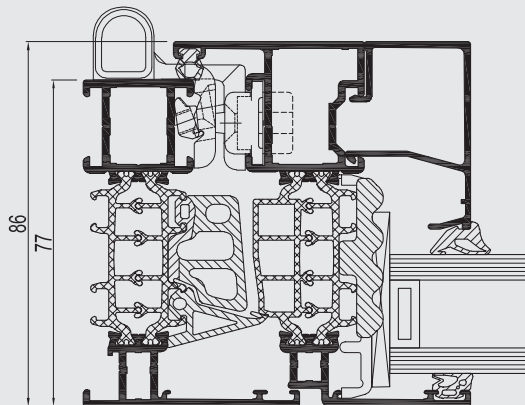
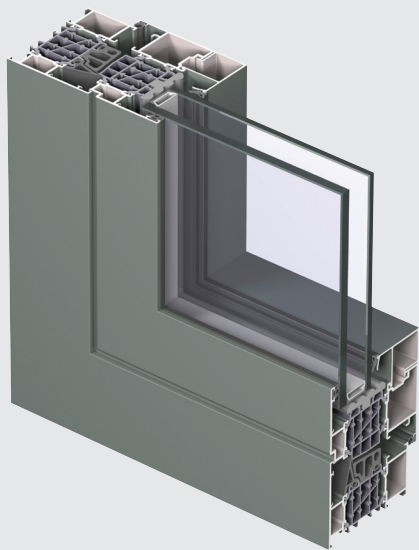

Concept System<sup>®</sup> 86-HI is a highly insulated system for windows and doors, which meets the highest requirements concerning safety and stability. The system's insulation concept not only ensures the extreme stability and elevated water- and air tightness, but also makes it perfectly suitable for triple glass applications.







The overall insulation value ( $U_f$ ) of the system's HI+ variant goes down to  $1.0 \text{ W/m}^2\text{K}$ . The frame/vent section with 117 mm visible width has a  $U_f$  value of  $1.4 \text{ W/m}^2\text{K}$ , making it one of the most energy-efficient systems available. CS 86 even achieved the Swiss Minergie<sup>®</sup> and Minergie-P<sup>®</sup> component label. With regard to safety, CS 86-HI can comply with burglar resistance classes 2 and 3, offering an ultimate level of security.



## TECHNICAL CHARACTERISTICS

			
Style variants		FUNCTIONAL	HIDDEN VENT
Min. visible width inward opening window	Frame	51 mm	70 mm
	Vent	35 mm	not visible
Min. visible width inward opening flush door	Frame	68 mm	-
	Vent	76 mm	-
Min. visible width outward opening flush door	Frame	42 mm	-
	Vent	102 mm	-
Min. visible width T-profile		76 mm	95 mm
Overall system depth window	Frame	77 mm	77 mm
	Vent	86 mm	79 mm
Rebate height		25 mm	17 mm
Glass thickness		up to 62 mm	up to 42 mm
Glazing method		dry glazing with EPDM or neutral silicones	
Thermal insulation		41 mm fibreglass reinforced polyamide strips in skeleton structure or omega/hollow chamber-shape	
High Insulation variant (HI)		Available	Available
High Insulation Plus variant (HI+)		Available	Not Available

## PERFORMANCES

ENERGY													
	Thermal insulation (1) EN ISO 10077-2	Uf-value down to 1.0 W/m <sup>2</sup> K depending on the frame/vent combination and the glass thickness											
COMFORT													
	Acoustic performance (2) EN ISO 140-3; EN ISO 717-1	Rw (C; Ctr) = 36 (-1; -4) dB / 44 (0; -2) dB, depending on glazing type											
	Air tightness, max. test pressure (3) EN 1026; EN 12207	1 (150 Pa)		2 (300 Pa)		3 (600 Pa)		4 (600 Pa)					
	Water tightness (4) EN 1027; EN 12208	1A (0 Pa)	2A (50 Pa)	3A (100 Pa)	4A (150 Pa)	5A (200 Pa)	6A (250 Pa)	7A (300 Pa)	8A (450 Pa)	9A (600 Pa)	E900 (900 Pa)		
	Wind load resistance, max. test pressure (5) EN 12211; EN 12210	1 (400 Pa)		2 (800 Pa)		3 (1200 Pa)		4 (1600 Pa)		5 (2000 Pa)		Exxx (> 2000 Pa)	
	Wind load resistance to frame deflection (5) EN 12211; EN 12210	A (≤ 1/150)			B (≤ 1/200)			C (≤ 1/300)					
SAFETY													
	Burglar resistance (6) NEN 5096 - ENV 1627	WK 1			WK 2 (windows & doors)				WK 3				

- (1) The Uf-value measures the heat flow. The lower the Uf-value, the better the thermal insulation of the frame.
- (2) The sound reduction index (Rw) measures the capacity of the sound reduction performance of the frame.
- (3) The air tightness test measures the volume of air that would pass through a closed window at a certain air pressure.
- (4) The water tightness testing involves applying a uniform water spray at increasing air pressure until water penetrates the window.
- (5) The wind load resistance is a measure of the profile's structural strength and is tested by applying increasing levels of air pressure to simulate the wind force. There are up to five levels of wind resistance (1 to 5) and three deflection classes (A,B,C). The higher the number, the better the performance.
- (6) The burglar resistance is tested by statistical and dynamic loads, as well as by simulated attempts to break in using specified tools.

HORIZONOV • [www.horizonov.ru](http://www.horizonov.ru) • [info@horizonov.ru](mailto:info@horizonov.ru)

г. Москва м. Юго-Западная, Киевское шоссе, 500 м от МКАД, БП «Румянцево», строение 2, вход 9, павильон 006В

REYNAERS ALUMINIUM NV/SA • [www.reynaers.com](http://www.reynaers.com) • [info@reynaers.com](mailto:info@reynaers.com)

07/2013 – 0H0.02C2.00 – Publisher Responsible at Law : E. Fonteyne, Oude Liersebaan 266, B-2570 Duffel

